

“ Je ne peux penser à l'eau sans y voir  
une source de fortification ”

Vauban



**INTERHYDRO<sup>®</sup>s.a.**

**FOURNITURES POUR L'EAU - EQUIPEMENT - TUBES - ACCESSOIRES**  
**WATER SUPPLIES - EQUIPMENT - PIPES - ACCESSORIES**



# BRANCHEMENT SERVICE CONNECTION

**COLLIERS DE PRISE  
EN CHARGE**  
CLAMP  
SADDLE

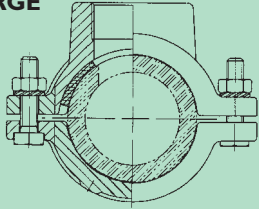

**ROBINET D'ARRET**  
STOP COCK

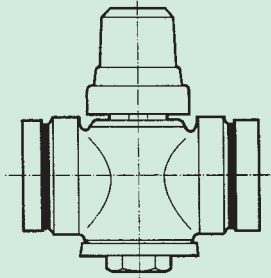

**ROBINET  
DE PRISE  
EN CHARGE**  
TAKE OFF  
COCK

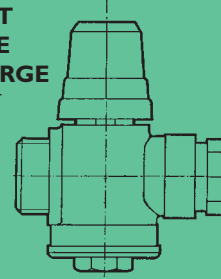

**BAC**  
SURFACE BOX

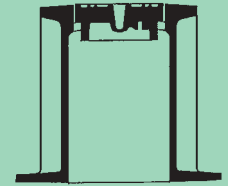

**ROBINET INVIOLEBLE**  
INVIOLEBLE WATER METER  
COCK

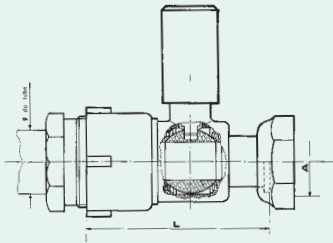

**ROBINET A POTENCE**  
KEY TYPE  
METER COCK

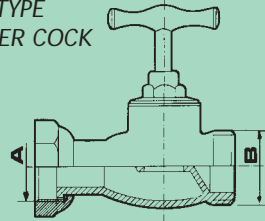

**TABERNACLE**  
RECEPTACLE  
FOR TAKE OFF  
COCK

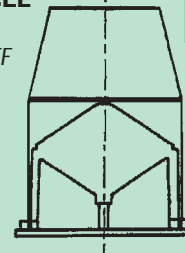

**ROBINET EQUERRE**  
90° KEY TYPE METER COCK

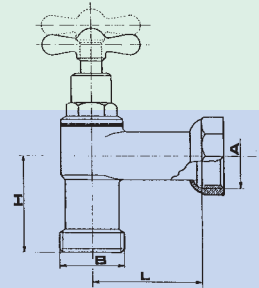

**ROBINET AVANT  
OU APRES  
COMPTEUR**  
METER COCK

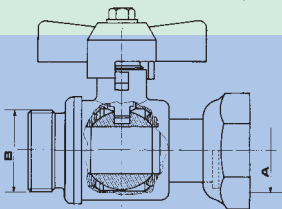

**ROBINET  
BOISSEAU  
SPHERIQUE**  
DOUBLE FEMALE BALL VALVE

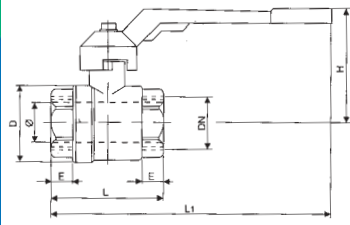

# COMPTAGE WATER MEASUREMENT AND CONTROL

**COMPTEURS JETS MULTIPLES**  
MULTI-JET WATER METER

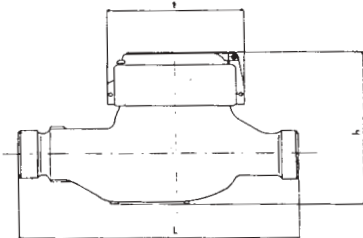

**COMPTEURS WOLTMAN**  
DOUBLE FLANGED  
WATER METER

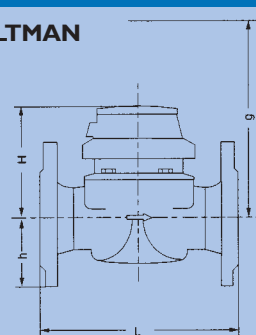

**DEBITMETRE**  
FLOW METER

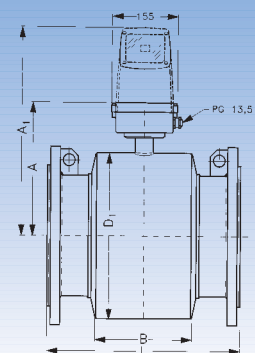



# RACCORDEMENT CONNECTING

**RACCORDS EN FONTE  
POUR PVC**  
DI FITTINGS  
FOR UPVC PIPES

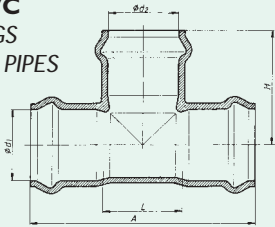

**RACCORDS EN FONTE A BRIDES**  
DI FLANGED FITTINGS

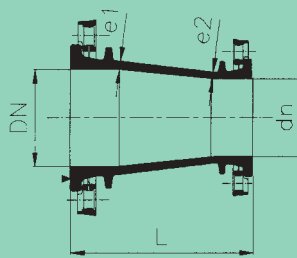

**RACCORDS EN FONTE POUR  
AMIANTE CIMENT**  
CAST IRON FITTINGS FOR AC PIPES

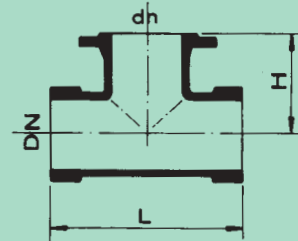

**RACCORDS EN FONTE POUR  
TUBE FONTE**  
DI FITTINGS  
FOR DI  
PIPES

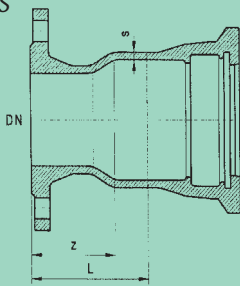

**JOINTS GIBAUT**  
STRAIGHT COUPLING

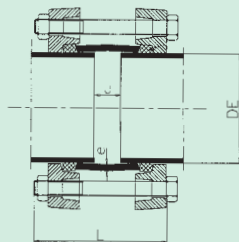

**ADAPTATEURS  
A BRIDE LARGE  
TOLERANCE**  
WIDE TOLERANCE  
ADAPTOR

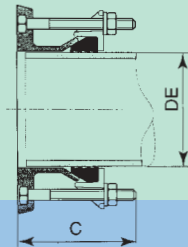

**ADAPTATEURS A BRIDE**  
FLANGE ADAPTOR

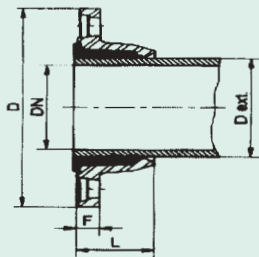

**JOINT DE DEMONTAGE  
AUTOBUTE**  
DISMANTLING JOINT

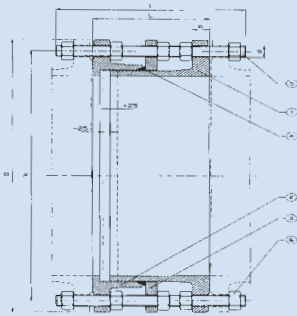

**MANCHON DE  
REPARATION**  
REPAIR CLAMP

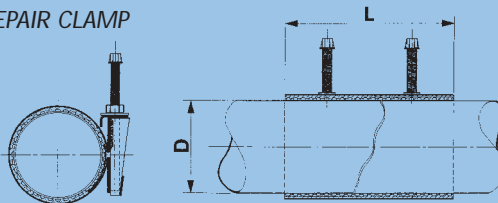

**RACCORDS EN LAITON  
A SERRAGE EXTERIEUR**  
BRASS FITTINGS FOR UPVC  
PIPES

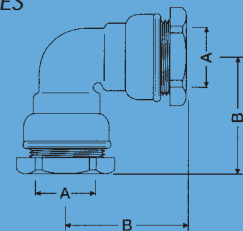

**RACCORDS GALVANISES**  
GALVANIZED FITTINGS

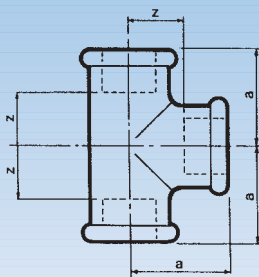

**BRIDES EN ACIER**  
STEEL FLANGES

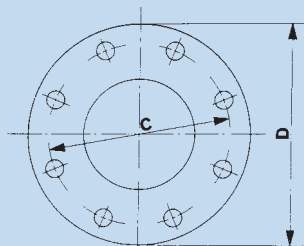

**COMPENSATEUR  
DE DILATATION**  
EXPANSION JOINT

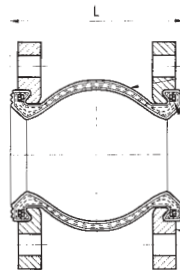

**RACCORDS EN PVC**  
UPVC FITTINGS  
FOR UPVC  
PIPES

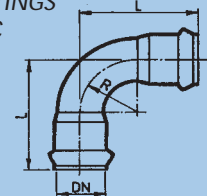

**TUBES FONTE À BRIDE**  
DI FLANGED PIPES

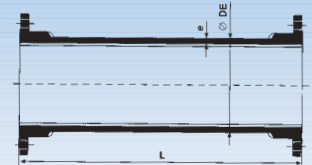



# SECTIONNEMENT STOP VALVES

**VANNE OPERCULE  
METALLIQUE**  
CAST IRON  
GATE VALVE

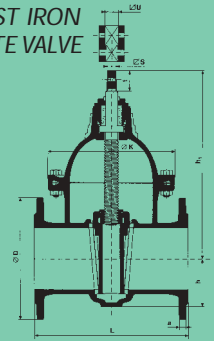

**VANNE OPERCULE  
CAOUTCHOUC**  
RUBBER WEDGE  
GATE VALVE

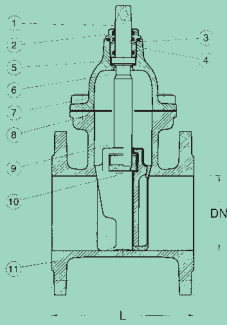

**VANNE  
PAPILLON  
A BRIDES**  
DOUBLE  
FLANGED  
BUTTERFLY  
VALVE

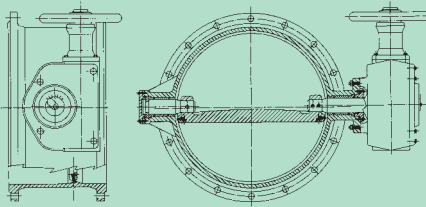

**CLAPET A BRIDES**  
DOUBLE FLANGED CHECK  
VALVE

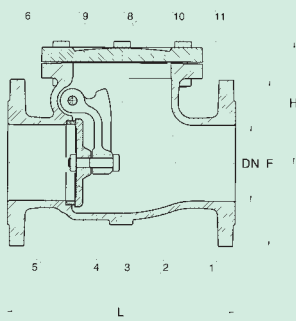

**ROBINET A SOUPAPE**  
CAST IRON GLOBE VALVE

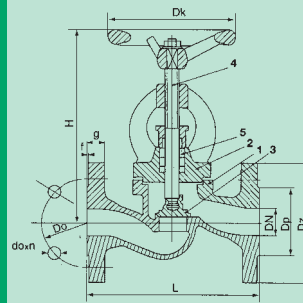

**CLAPET SANDWICH**  
CHECK VALVE WAFER TYPE

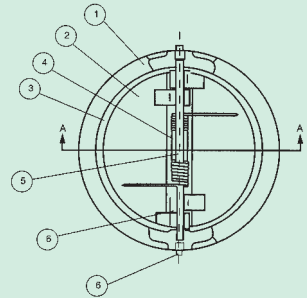

**VANNE PAPILLON  
SANDWICH**  
BUTTERFLY VALVE  
WAFER TYPE

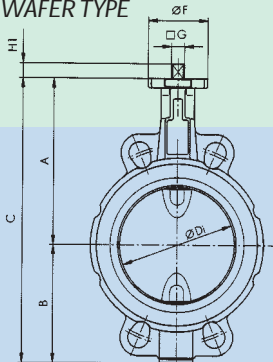

**BONDE  
DE FOND**  
MUD VALVE

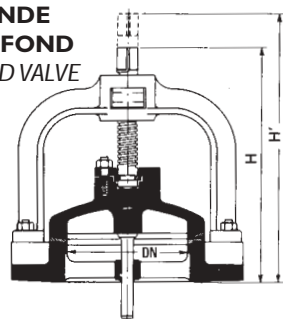

**VANNE GUILLOTINE**  
KNIFE GATE VALVE

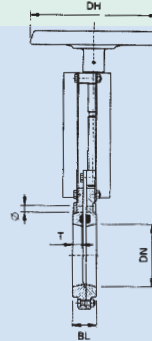

**VANNETTE LAITON**  
BRASS GATE  
VALVE

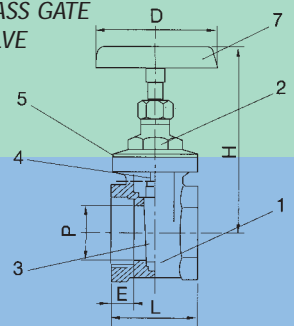

**ROBINET  
DE PUISAGE  
TETE DROITE**  
TAP WITH  
HOSE COUPLING

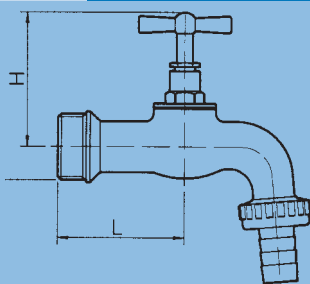

**ROBINET DE PUISAGE SPHERIQUE**  
BALL BIBCOCK  
HOSE COUPLING

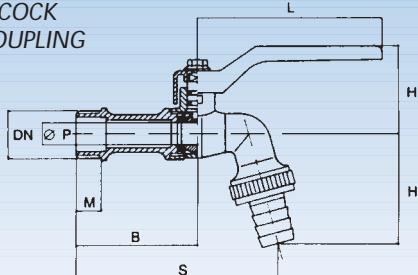

**VANNE BOISSEAU  
SPHERIQUE A BRIDES**  
DOUBLE FLANGED BALL VALVE

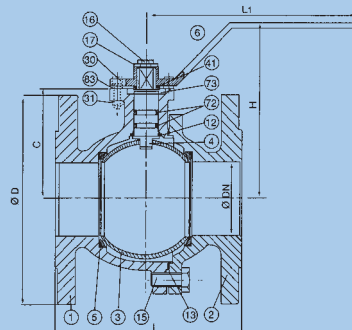

**CLAPET PAPILLON**  
BUTTERFLY CHECK  
VALVE

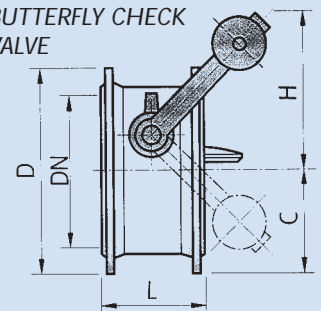

**CLAPET  
LINEAIRE**  
SPRING  
CHECK  
VALVE

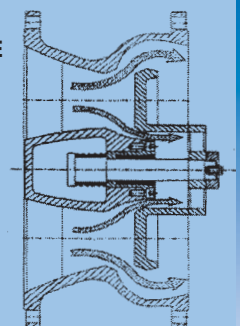



# PROTECTION ET RÉGULATION

## PROTECTION AND PIPE REGULATION

**SOUPAGE ANTI BELIER**  
ANTI-HAMMER VALVE

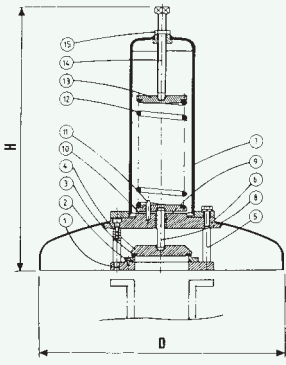

**ROBINET FLOTTEUR**  
FLOAT VALVE

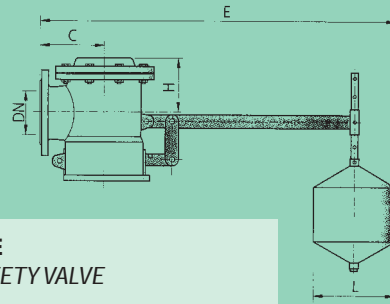

**VANNE DE SURVITESSE**  
AUTOMATIC SHUT OFF SAFETY VALVE

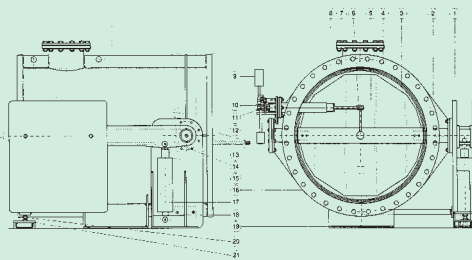

**BALLON ANTI BELIER**  
ANTI-HAMMER TANK

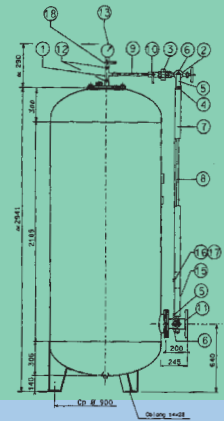

**OBTURATEUR A FLOTTEUR**  
EQUILIBRATED FLOAT VALVE

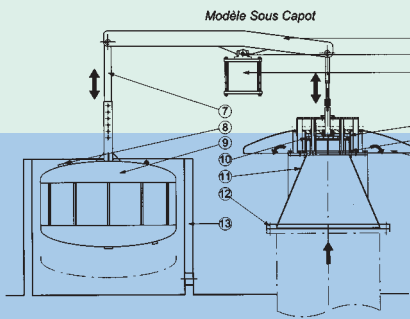

**STABILISATEUR AMONT ET AVAL**  
UPSTREAM AND DOWNSTREAM SUSTAINING VALVE

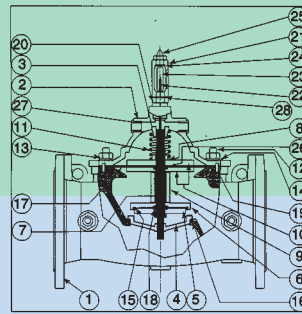

**REDUCTEUR DE PRESSION**  
PRESSURE REDUCING VALVE

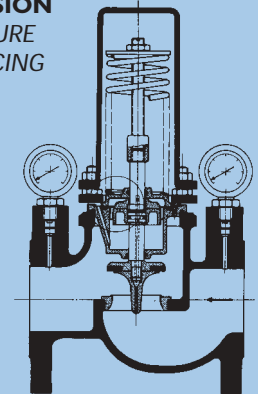

**VENTOUSE 1 FONCTION**  
SINGLE ACTION AIR RELEASE VALVE

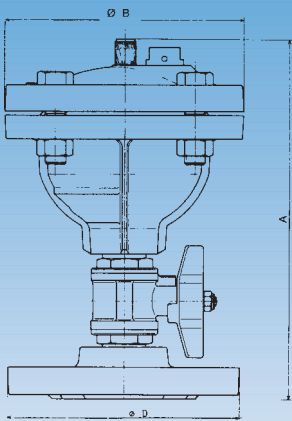

**VENTOUSE 2 FONCTIONS**  
DOUBLE ACTION AIR RELEASE VALVE

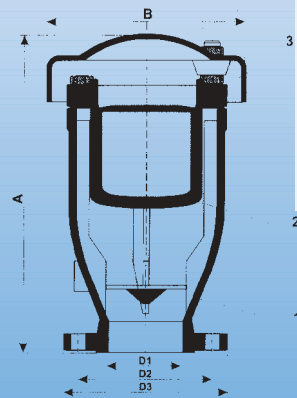

**VENTOUSE 3 FONCTIONS**  
KINETIC AIR RELEASE VALVE

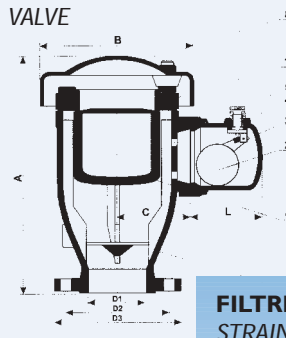

**FILTRE BB**  
STRAINER -

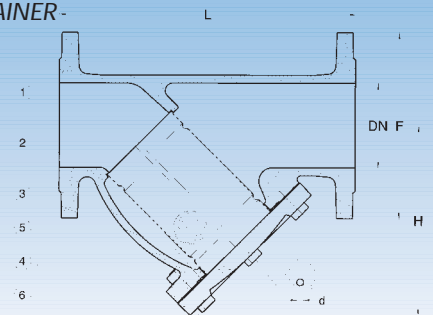



# IRRIGATION IRRIGATION

**MODULES A MASQUES**  
BAFFLE DISTRIBUTOR

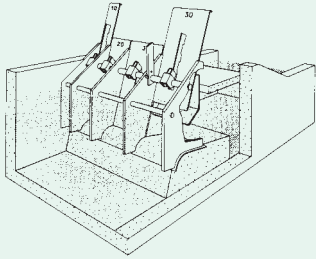

**VANNE VANAC**  
CONSTANT UPSTREAM  
LEVEL GATE

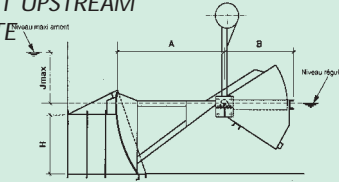

**VANNE VANIS**  
CONSTANT DOWNSTREAM  
LEVEL GATE

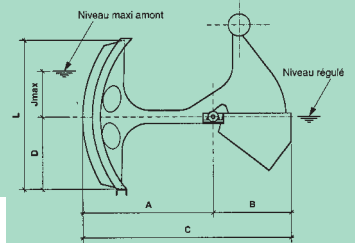

**BORNE IRRIGATION**  
IRRIGATION HYDRANT

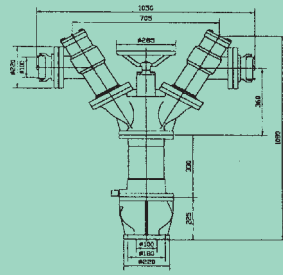

**CLAPET DE NEZ**  
CHECK  
FLAP VALVE

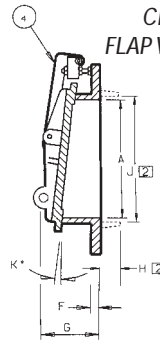

**VANNE BATARDEAU**  
CANAL GATE

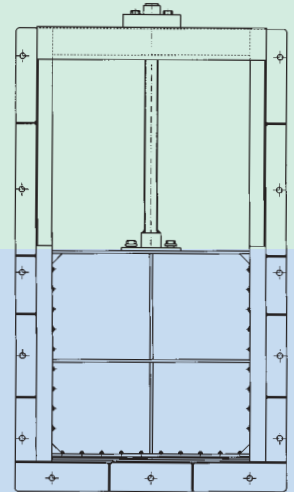

**VANNE CALIFORNIENNE**  
OVERFLOW RISER VALVE

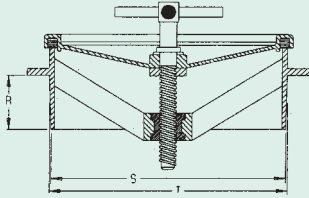

**VANNE MURALE**  
SLIDE GATE

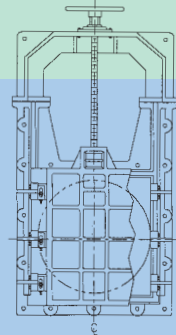

**VANNE CLAPET**  
TILTING WEIR GATE

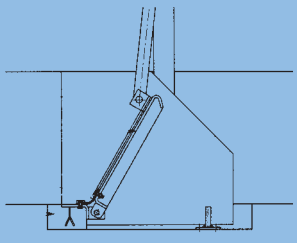

**VANNE SECTEUR**  
RADIAL GATE

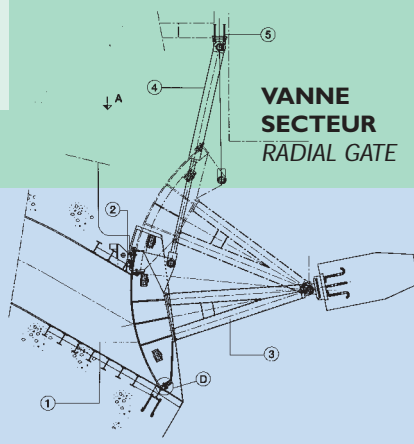

# ASSAINISSEMENT SEWAGE EQUIPMENT



**CLAPET A BOULE**  
DOUBLE  
FLANGED  
BALL CHECK  
VALVE

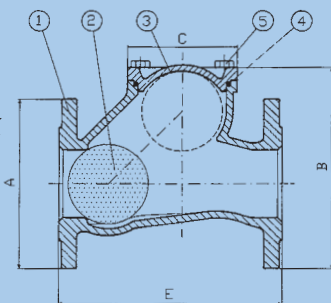

**PLAQUES FONTE**  
REGARD  
MANHOLE  
COVER AND  
GRATING

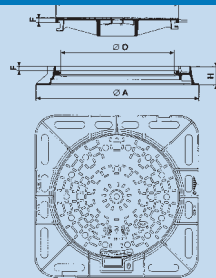

**VENTOUSE**  
SEWAGE AIR  
RELEASE VALVE

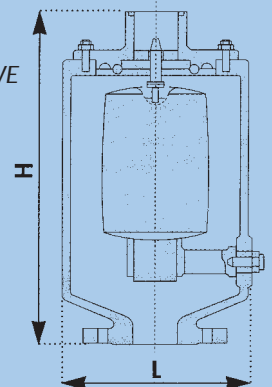



# BARRAGE DAM EQUIPMENT

**VANNE OPERCULE PARALLELE**  
PARALLEL  
SLIDE  
GATE VALVE

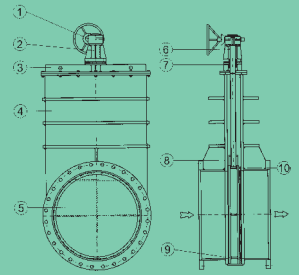

**VANNE PAPILLON A GRANDE  
VITESSE**  
DISCHARGE  
BUTTERFLY  
VALVE

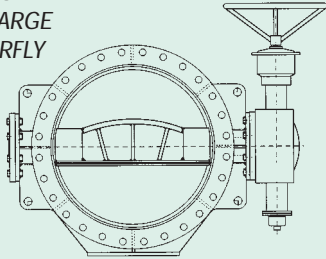

**VANNE WAGON**  
WAGON TYPE VALVE

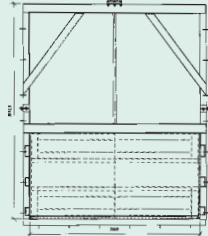

**VANNE JET  
CREUX**  
HOLLOW  
JET VALVE

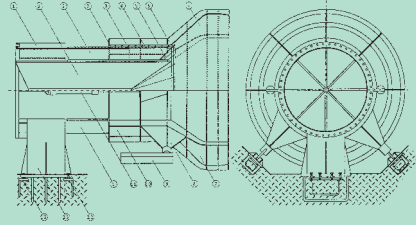

# INCENDIE FIRE PROTECTION

**BOUCHE INCENDIE**  
UNDERGROUND FIRE HYDRANT

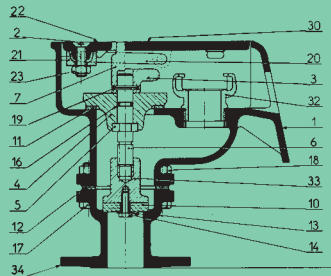

**POTEAU INCENDIE**  
PILLAR FIRE HYDRANT

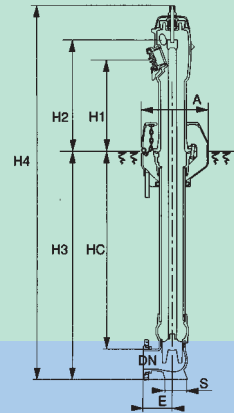

# POMPAGE PUMPING

**POMPE D'EPREUVE A MAIN**  
MANUAL TEST PUMP

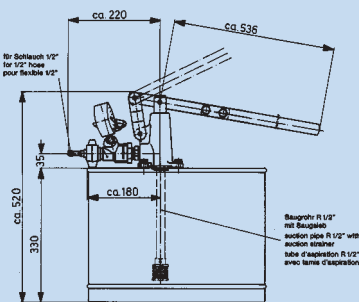

**POMPE IMMERGEE**  
SUBMERSIBLE PUMP

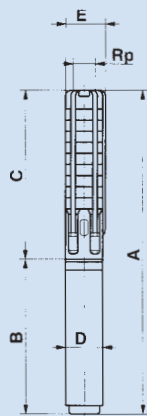

**POMPE DE RELEVAGE**  
WASTE WATER AND SEWAGE  
PUMP

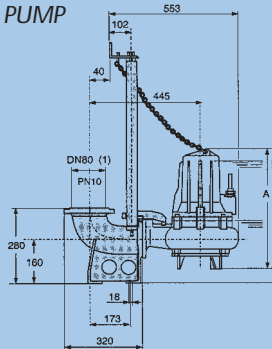

**CLAPET DE PIED**  
LIFT FOOT VALVE

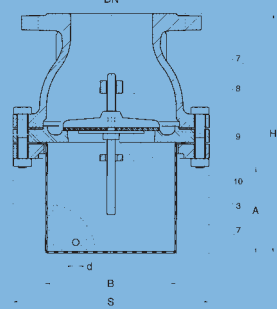

**POMPE  
D'EPREUVE MOTORISEE**  
MOTOR  
DRIVEN  
TEST  
PUMP

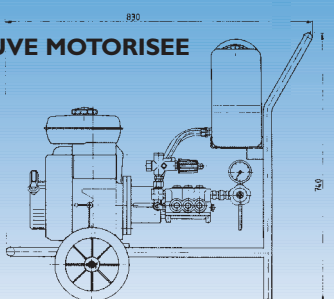

**GRUPE MOTOPOMPE**  
MOTOR PUMP  
SET

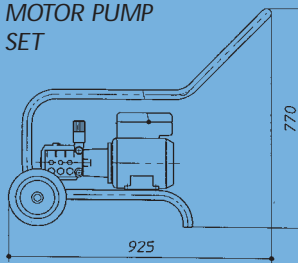

**POMPE  
DOSEUSE**  
DOSING  
PUMP

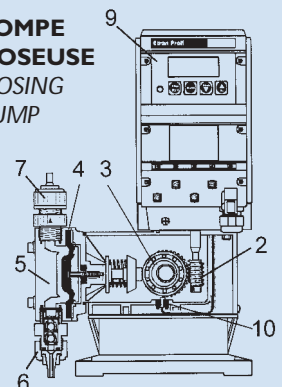

# INTERHYDRO, la solution-produit à toutes vos exigences.

Spécialiste de la fourniture d'équipements destinés à l'adduction d'eau, à l'irrigation et aux barrages INTERHYDRO s'efforce d'élargir sans cesse sa gamme afin de répondre au mieux à la demande dans tous les domaines de l'eau.

Aujourd'hui, INTERHYDRO est présent dans plus de 40 pays. Les tubes, la régulation, la protection et le sectionnement des conduites (répondant aux normes internationales) acheminés chaque jour à l'étranger contribuent au développement des pays et apportent confort aux populations.

Cette marque de confiance est due :

- à l'expertise,
- à la qualité et la fiabilité des produits,
- à la souplesse de l'organisation,
- à la largeur de gamme proposée :
  - des diamètres de 15 à 3200 mm
  - des pressions de PN 10 à PN 100
- aux choix des matériaux : acier, PVC, fonte, PEHD...

- BRANCHEMENT
- COMPTAGE
- SECTIONNEMENT
- PROTECTION ET RÉGULATION
- IRRIGATION
- ASSAINISSEMENT
- BARRAGE
- INCENDIE
- POMPAGE
- RACCORDEMENT

Quels que soient vos besoins dans le domaine de l'eau, INTERHYDRO apporte une réponse fiable.

## INTERHYDRO, a product range meeting all your needs.

INTERHYDRO makes equipment for the water mains, irrigation and dams. INTERHYDRO continually extends the range to meet demand in every aspect of water use. INTERHYDRO is active in more than 40 countries. The pipes, regulation, protection and section control systems (meeting international standards) which are shipped every day contribute to the development of the countries concerned and raise the standards of living of their populations.

The INTERHYDRO's success and the loyalty of its customers is due to :

- the expertise,
- the quality and reliability of the products,
- the flexibility of the organization,
- the very large product range supplied :
  - diameters from 15 to 3200 mm
  - pressures from NP 10 to NP 100
- the choice of materials : steel, U-PVC, ductile iron, HDPE...

- SERVICE CONNECTION
- WATER MEASUREMENT AND CONTROL
- STOP VALVES
- PROTECTION AND PIPES REGULATION
- IRRIGATION
- SEWAGE EQUIPMENT
- DAM EQUIPMENT
- FIRE PROTECTION
- PUMPING
- CONNECTING

Whatever you need for water, INTERHYDRO is a reliable supplier.

 Des diamètres de 15 à 3200 mm  
Diameter 15 mm up to 3200 mm.

 Des pressions de PN 10 à PN 100  
Pressure from NP 10 to NP 100 bars.



# INTERHYDRO® s.a.

17, chemin Louis Chirpaz - 69130 ECULLY - France - Tél. 33 (0)4 78 33 09 09 - Fax 33 (0)4 78 33 07 28  
E-mail : [interhydro@wanadoo.fr](mailto:interhydro@wanadoo.fr) - Internet : [www.interhydro.com](http://www.interhydro.com)